

MONTERINGSANVISNING: ROTO-TOP

DETALJER



Mutter (1) och
bricka (1)



Ögleskruv (1)



Fixlock (1)

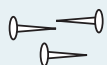

Skrubar (3)

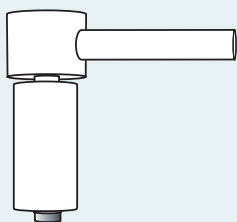

Roto-top 56 mm i diameter (1)



Aluminiumarm 1540 mm (1)

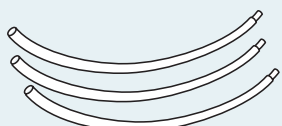

Plastslingor med nippel (3)

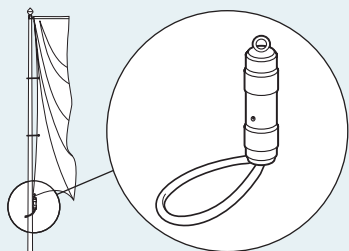

TILLVAL: Motvikt (1) och ring (1).
Gör att flaggan hålls rak.

1 För på aluminiumarmen på er Roto-Top.

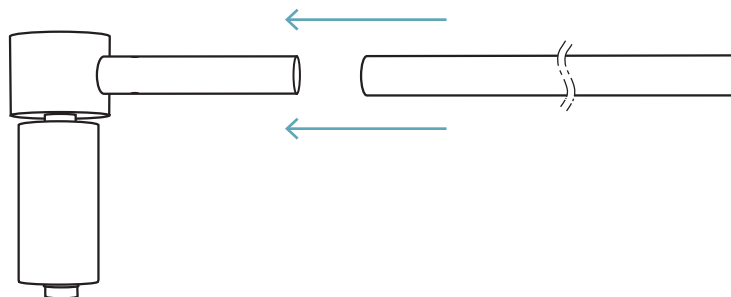

2 Skruva fast aluminiumarmen.

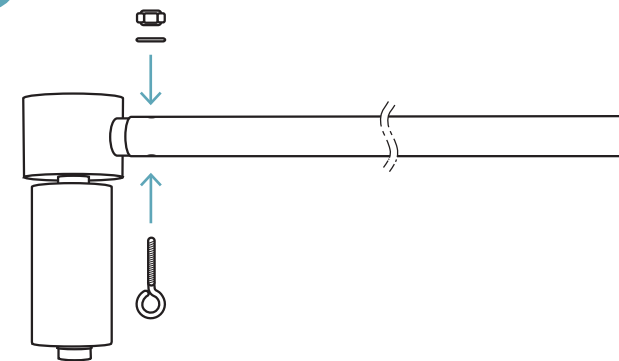

3 För ner er Roto-Top i flaggstången.

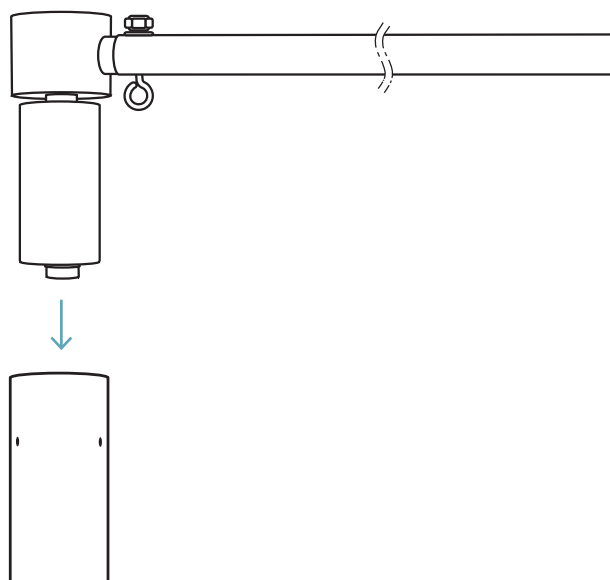

4 Skruva fast er Roto-Top i flaggstången (med tre skruvar) och fäst flaggstångsknoppen.

